

Nose Equipment - Lockbolt Systems

Equipements - Systèmes de boulons à sertir / Ausrüstungen - Schließringbolzen-Systeme / Testate - Sistemi di bulloni a strappo/ Equipos de colocación - Sistemas de pernos estructurales

In this table you will find the correct nose equipment (A) for your basic tool and lockbolt.

Dans ce tableau, vous trouverez l'équipement de pose (A) adapté à vos outils nus par boulon à sertir.

In dieser Tabelle finden Sie die passende Nietausrüstung (A) für Ihr Grundgerät und Schließringbolzen.

Nel riquadro potrete trovare i corretti equipaggiamenti (A) per i vostri attrezzi per piazzare bulloni a strappo.

En esta tabla usted encontrará la boquilla de colocación (A) adecuada para su máquina y perno estructural.

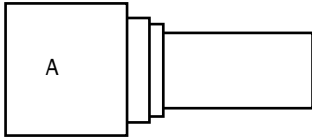

Type Genesis® G2 LB & nG4
Type/Typ/Tipo Genesis® G2 LB & nG4

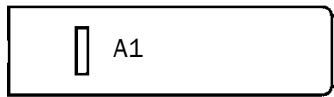

straight round / droit rond /
gerade rund / diritta arrotondata /
recta circular



straight with horizontal flats / droit à mé-
plats horizontaux / horizontal abgeflacht
/ diritta con parti piatte orizzontali / recta
con planos horizontales

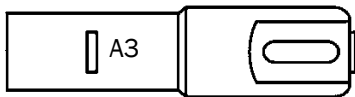

straight with vertical flats / droit à
méplats verticaux / vertikal abgeflacht
/ diritta con parti piatte verticali / recta
con planos verticales

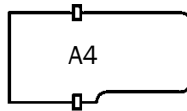

straight short / droit court /
gerade kurz / diritta corta /
recta corta

Brand & Series Gamme & Série Produkt & Serie Prodotto & Serie Producto & Serie	Ø mm (inch)	Part No./ref. basic tool and equipment / Réf/ Outil nu et équipement			
		Type Genesis® G2 LB 71255-02000	Type Genesis® nG4 71234-02000	Type 722 07220-00200	Type 7267 07267-00200 & Type 7287 07287-00200
Avdelok®	4.8 (3/16")	A: 71230-05010	A: 71230-05010	A2: 07200-02700 ¹⁾ A3: 07200-02500 ¹⁾	A2: 07200-02700 ¹⁾ A3: 07200-02500 ¹⁾
	6.4 (1/4")	A: 71230-05020	A: 71230-05020	A1: 07200-03500 ¹⁾ A2: 07200-02800 ¹⁾ A2 ²⁾ : 07200-02600 ¹⁾ A3: 07200-03300 ¹⁾	A1: 07200-03500 ¹⁾ A2: 07200-02800 ¹⁾ A2 ²⁾ : 07200-02600 ¹⁾ A3: 07200-03300 ¹⁾
	8.0 (5/16")	-	-	A1: 07220-05600 A2: 07220-02700 A2 ²⁾ : 07220-03400	A1: 07220-05600 A2: 07220-02700 A2 ²⁾ : 07220-03400
	9.6 (3/8")	-	-	A1: 07220-02000 A1 ²⁾ : 07220-03500 A4: 07220-06100	A1: 07220-02000 A1 ²⁾ : 07220-03500 A4: 07220-06100

¹⁾ Adaptor required part-no. 07220-02500 / adaptateur (référence 07220-02500) est nécessaire / plus erforderlicher Adapter Art.-Nr. 07220-02500 / è necessario utilizzare un adattatore (codice 07220-02500) / es necesario utilizar el adaptador (referencia 07220-02500)

²⁾ stepped version / en escalier / abgesetzt / a gradini / escalonada

Nose Equipment - Lockbolt Systems

Equipements - Systèmes de boulons à sertir / Ausrüstungen - Schließringbolzen-Systeme / Testate - Sistemi di bulloni a strappo/ Equipos de colocación - Sistemas de pernos estructurales



AV10



AV30³⁾

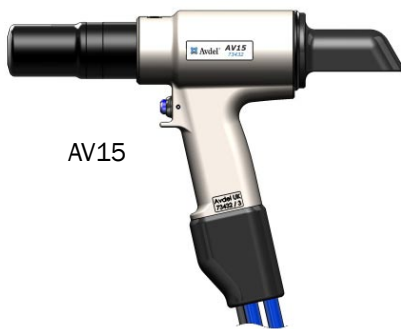

AV15



AV50³⁾

Brand & Series Gamme & Série Produkt & Serie Prodotto & Serie Producto & Serie	Ø mm (inch)	Part No./ref. basic tool and equipment / Réf/ Outil nu et équipement			
		Type 734 AV™ AV15 73432-02000	Type 734 AV™ AV30 73434-02000 ³⁾	Type 734 AV™ AV50 73435-02000 ³⁾	
Infalok®	12.7 (1/2")	73432-03200 ⁴⁾ 73433-03200 ⁵⁾	73412-03100 ⁵⁾	-	
	15.9 (5/8")	-	73412-03200 ⁵⁾	-	
	19.1 (3/4")	-	73412-03300 ⁵⁾	-	
	22.2 (7/8")	-	-	73410-03200 ⁵⁾	
	25.4 (1")	-	-	73410-03100 ⁵⁾	
	28.6 (1 1/8")	-	-	73410-03300 ⁵⁾	

Brand & Series Gamme & Série Produkt & Serie Prodotto & Serie Producto & Serie	Ø mm (inch)	Part No./ref. basic tool and equipment / Réf/ Outil nu et équipement				
		Type 722 07220-00200	Type 7267 07267-00200 & Type 7287 07287-00200	Type 734 AV™ AV10 73430-02000	Type 734 AV™ AV15 73432-02000	Type 734 AV™ AV30 73434-02000 ³⁾
Avbolt®	4.8 (3/16")	07220-08100	07220-08100	-	-	-
	6.4 (1/4")	07220-07500	07220-07500	-	-	-
	8.0 (5/16")	07220-07700	07220-07700	73430-03300 ⁴⁾	-	-
	10.0 (3/8")	-	-	73430-03200 ⁴⁾	-	-
	12.7 (1/2")	-	-	-	73432-03100 ⁴⁾ 73433-03100 ⁵⁾	73412-03600 ⁵⁾
	16.0 (5/8")	-	-	-	-	73412-03400 ⁵⁾

³⁾ advanced information / sous réserve de confirmation / vorläufige Information / informazioni solo anticipate / solo informativo

⁴⁾ without jaw release / ohne freigebende Spannbacken / senza rilascio ganasce

⁵⁾ with jaw release / mit freigebenden Spannbacken / con rilascio ganasce



Nose Equipment - Lockbolt Systems

Equipements - Systèmes de boulons à sertir / Ausrüstungen - Schließringbolzen-Systeme / Testate - Sistemi di bulloni a strappo/ Equipos de colocación - Sistemas de pernos estructurales

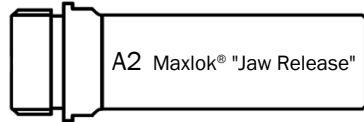
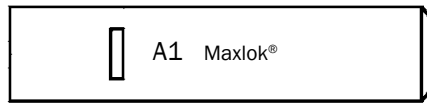

nose assembly / équipement droit ronde / Ausrüstung / testata / boquilla

Brand & Series Gamme & Série Produkt & Serie Prodotto & Serie Producto & Serie	Ø mm (inch)	Part No./ref. basic tool and equipment / Réf/ Outil nu et équipement					
		Type Genesis® G2 LB 71255-02000	Type Genesis® nG4 71234-02000	Type 7265 07265-00300	Type 7267 07267-00200	Type 7287 07287-00200	
Maxlok®	1901	4.8 (3/16")	A1: 07610-02000 ⁶⁾	A1: 07610-02000 ⁶⁾	A1: 07610-02000 ⁷⁾	A1: 07610-02000 ⁸⁾	A1: 07610-02000 ⁸⁾
	1902		A2: 71234-03600				
	1903	6.4 (1/4")	-	A1: 07610-02100 ⁹⁾	A1: 07610-02100 ⁷⁾	A1: 07610-02100 ⁸⁾	A1: 07610-02100 ⁸⁾
	1905			A2: 71234-03500			
	1921						
Avtainer®	2311	10.0 (3/8")	A: 71230-15600 ⁹⁾	A: 71230-15600 ⁹⁾	A: 07498-00800	A: 07498-00800 ¹⁰⁾	A: 07498-00800 ¹⁰⁾

⁶⁾ Adaptor required part-no. 71234-03400 / adaptateur (référence 71234-03400) est nécessaire / plus erforderlicher Adapter Art.-Nr. 71234-03400 / è necessario utilizzare un adattatore (codice 71234-03400) / es necesario utilizar un adaptador (referencia 71234-03400)

⁷⁾ Adaptor required part-no. 07265-02900 / adaptateur (référence 07265-02900) est nécessaire / plus erforderlicher Adapter Art.-Nr. 07265-02900 / è necessario utilizzare un adattatore (codice 07265-02900) / es necesario utilizar un adaptador (referencia 07265-02900)

⁸⁾ Adaptor required part-no. 07220-02500 / adaptateur (référence 07220-02500) est nécessaire / plus erforderlicher Adapter Art.-Nr. 07220-02500 / è necessario utilizzare un adattatore (codice 07220-02500) / es necesario utilizar un adaptador (referencia 07220-02500)

⁹⁾ Nose piece required part-no. 07498-00802 / nez de pose (référence 07498-00802) est nécessaire / plus erforderliches Mundstück Art.-Nr. 07498-00802 / è necessario utilizzare un nasello (codice 07498-00802) / es necesario utilizar una sufridera (referencia 07498-00802)

¹⁰⁾ Adaptor required part-no. 07267-00800 / adaptateur (référence 07267-00800) est nécessaire / plus erforderlicher Adapter Art.-Nr. 07267-00800 / è necessario utilizzare un adattatore (codice 07267-00800) / es necesario utilizar el adaptador (referencia 07267-00800)

Please always refer to the tool manual for correct installation of adaptors / Merci de consulter le manuel de l'outil pour un montage correct des adaptateurs / Zum korrekten Einbau der Adapter folgen Sie bitte den Anweisungen in der Betriebsanleitung / Per le istruzioni di montaggio dell'adattatore prego fare riferimento al manuale dell'attrezzo/ Por favor, consulte siempre el manual de la máquina para la correcta instalación de los adaptadores.

Nose Equipment 734 HAT Tool - Lockbolt Systems

Equipements - Systèmes de boulons à sertir / Ausrüstungen - Schließringbolzen-Systeme / Testate - Sistemi di bulloni a strappo/ Equipos de colocación - Sistemas de pernos estructurales

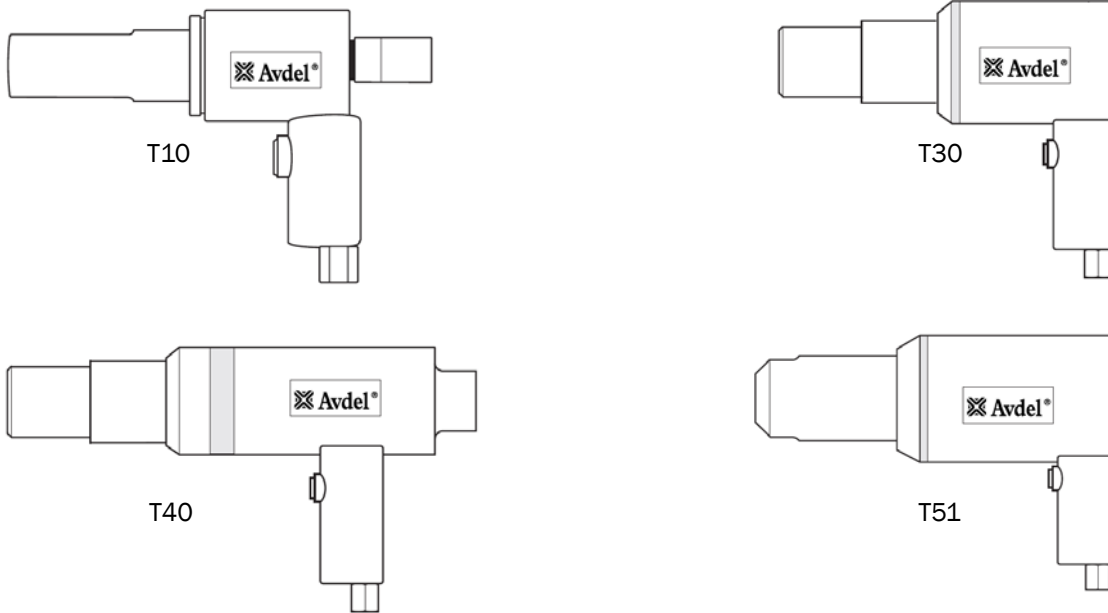

Brand & Series Gamme & Série Produkt & Serie Prodotto & Serie Producto & Serie	Ø mm (inch)	Part No./ref. basic tool and equipment / Réf/ Outil nu et équipement			
		Type 734 HAT 7340x-02000 + T30 73412-02000	Type 734 HAT 7340x-02000 + T40 73414-02000	Type 734 HAT 7340x-02000 + T51 73410-02000	
Avdelok® LD 2861	12.7 (1/2")	73412-03100	73412-03100	-	
	15.9 (5/8")	73412-03200	73412-03200	-	
	19.1 (3/4")	73412-03300	73412-03300	-	
	22.2 (7/8")	-	-	73410-03200	
	25.4 (1")	-	-	73410-03100	
	28.6 (1 1/8")	-	-	73410-03300	

Brand & Series Gamme & Série Produkt & Serie Prodotto & Serie Producto & Serie	Ø mm (inch)	Part No./ref. basic tool and equipment / Réf/ Outil nu et équipement			
		Type 734 HAT 7340x-02000 + T10 73411-02000	Type 734 HAT 7340x-02000 + T30 73412-02000		
Avbolt®	21021	8.0 (5/16")	73411-03300	-	
	21001	10.0 (3/8")	73411-03200	-	
		12.7 (1/2")	-	73412-03600	
		16.0 (5/8")	-	73412-03400	

